

aqua

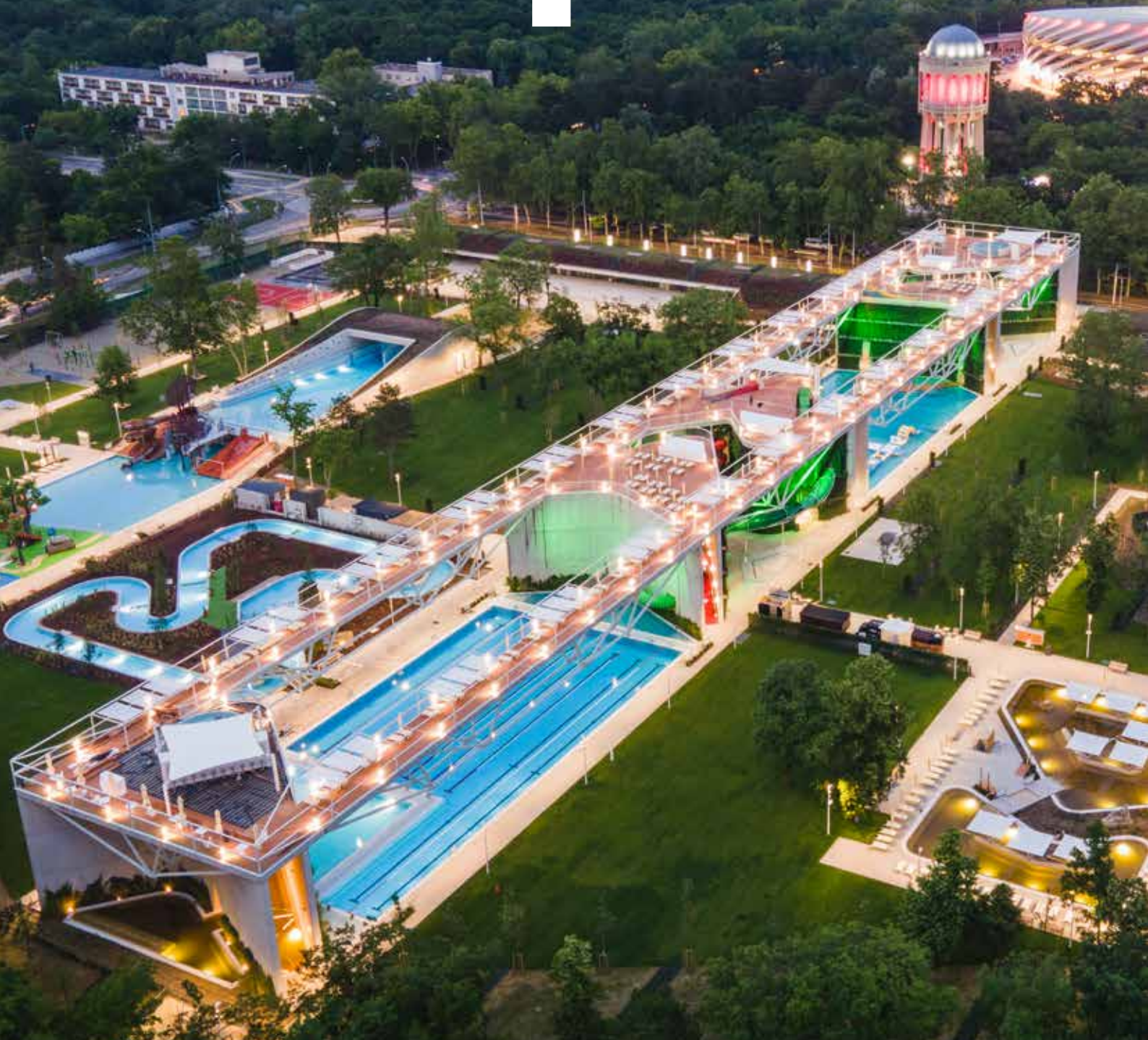

ROSA
GRES

INDEX

INTRODUCTION	pg. 03
PROJECTS	pg. 04
THE EDGE DECK LEVEL POOL SYSTEMS	pg. 08
THE TANK	pg. 16
POOL DECKS	pg. 20
CHANGING ROOMS	pg. 24
ACCESSORIES	pg. 28
TECHNICAL INFORMATION	pg. 30

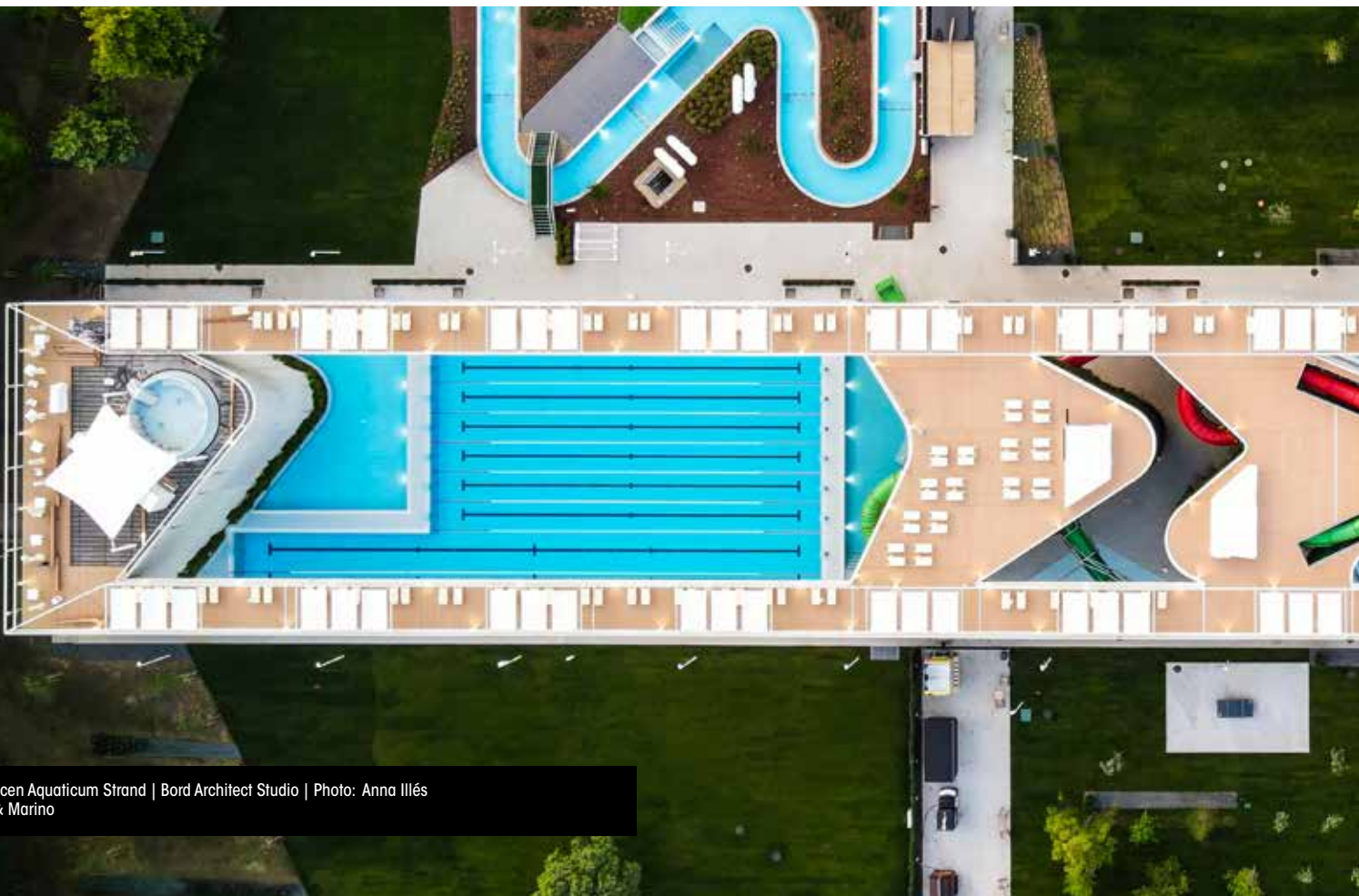

AQUA BY ROSA GRES: UNIQUE SOLUTIONS FOR UNIQUE POOLS

Over 40 years of experience in the pool industry and thousands of projects throughout the world are the keys to our specialization: **manufacturing porcelain stoneware solutions to facilitate the design and construction of swimming pools, from beginning to end.**

Complete solutions are essential since they support the entire creation and construction process: design and architecture, as well as choosing the most appropriate construction system and the perfect placement product.

Solutions for offering an excellent service. Thanks to our technical consulting team, which is specialized in advising architects; and our online resources, with the new collection of **BIM objects** now available.

Innovative solutions, such as our porcelain grids, available in over 30 colors and which won a 2016 Architizer Award; and our **exclusive anti-slip finishes**, comfortable and easy to clean.

Flexible and practical solutions that can be applied to any kind of swimming pool project: for competitions, sports, hotels, Wellness areas, public or private.

Design solutions. Four high-quality porcelain stoneware and mosaic color programs. Over 70 shades and textures, a diversity of formats and a specific range of pieces designed specifically for swimming pools.

Designing solutions is a fascinating mission. It involves discovering, innovating and improving. With this new catalog, **Aqua**, our goal is not only diverse but also unique and exciting: **for our solutions to provide the best help when carrying out your projects.**

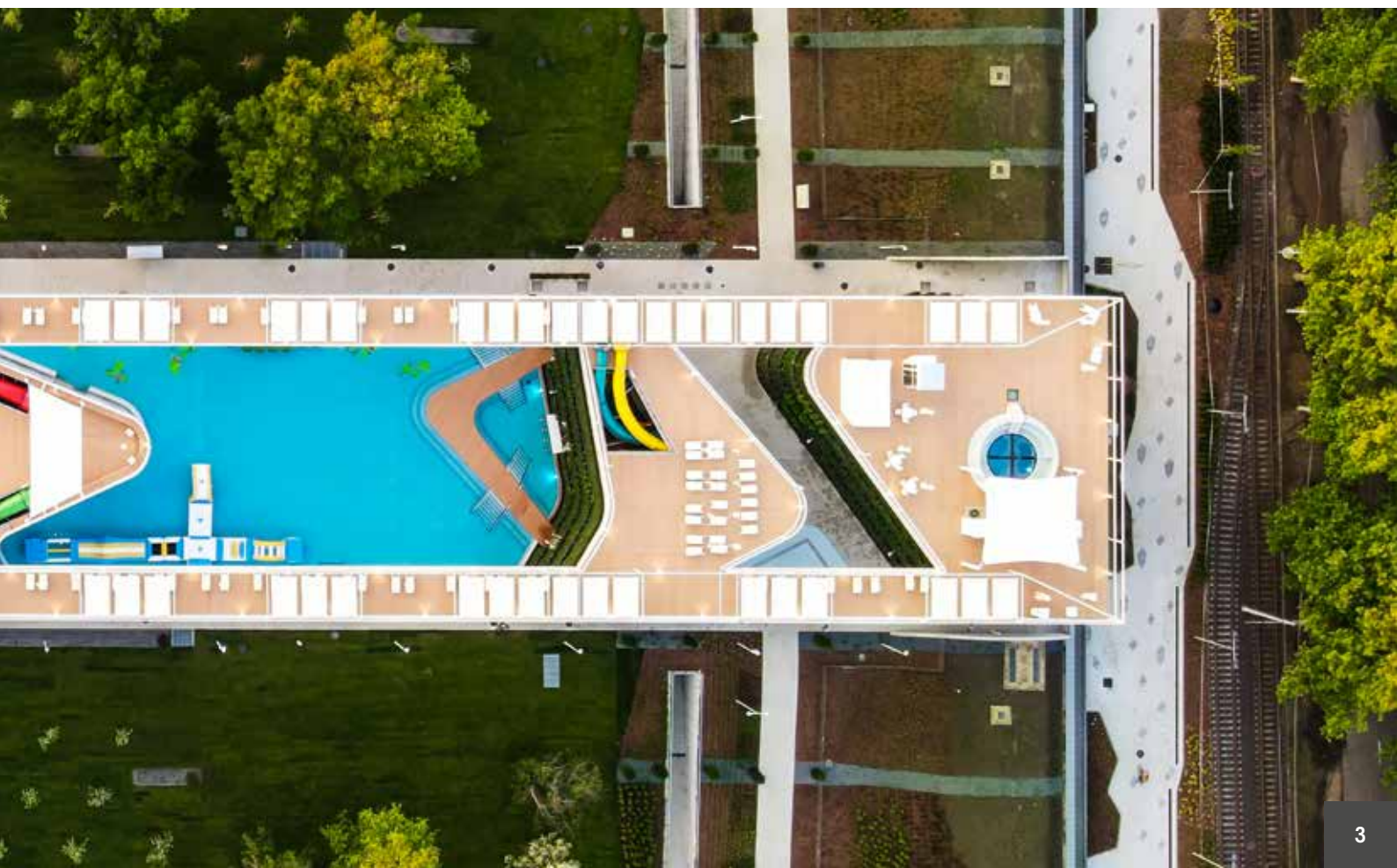

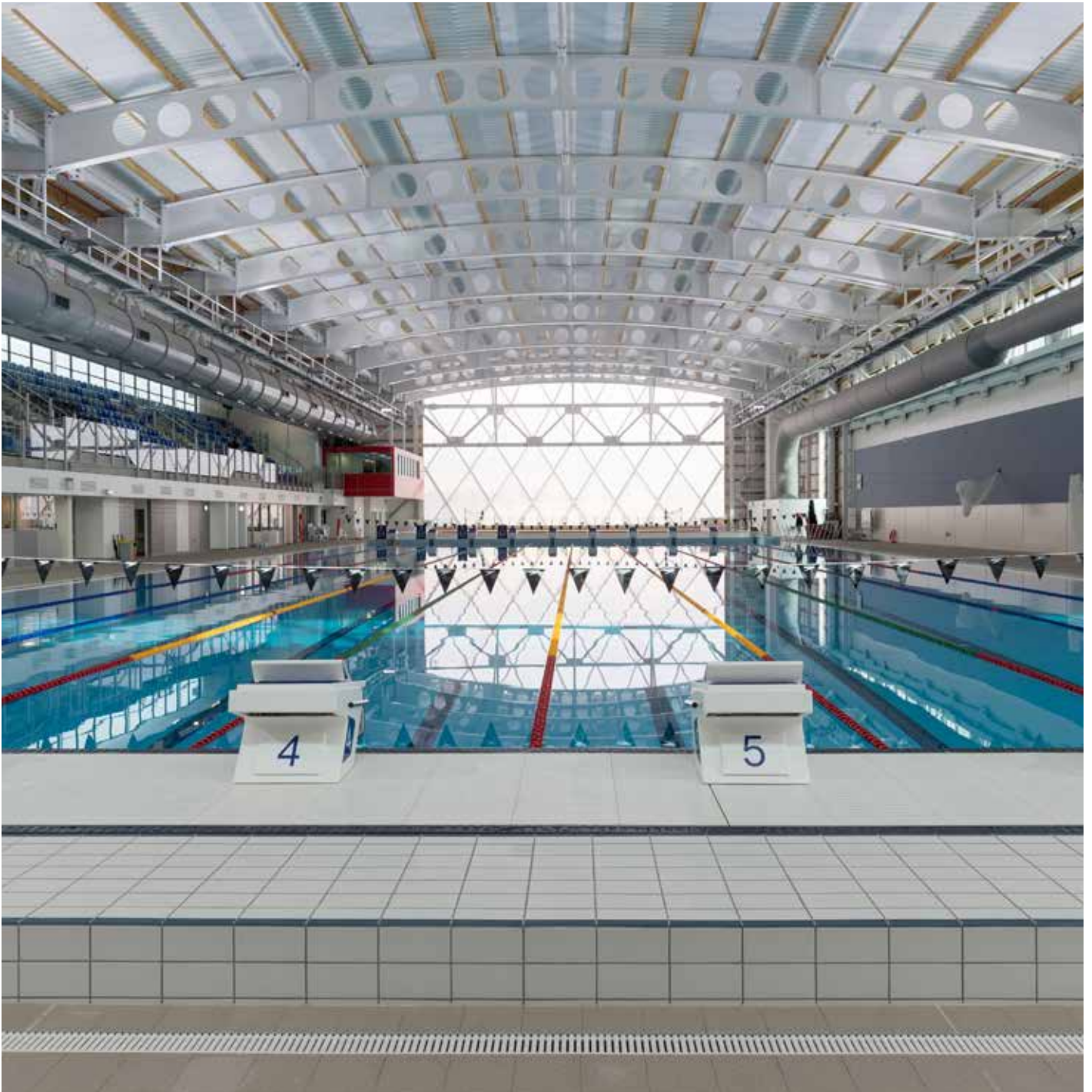

**SIR OWEN G. GLENN NATIONAL AQUATIC CENTER
AUCKLAND, NEW ZEALAND**

Olympic Pool

Ergo System / Blanco



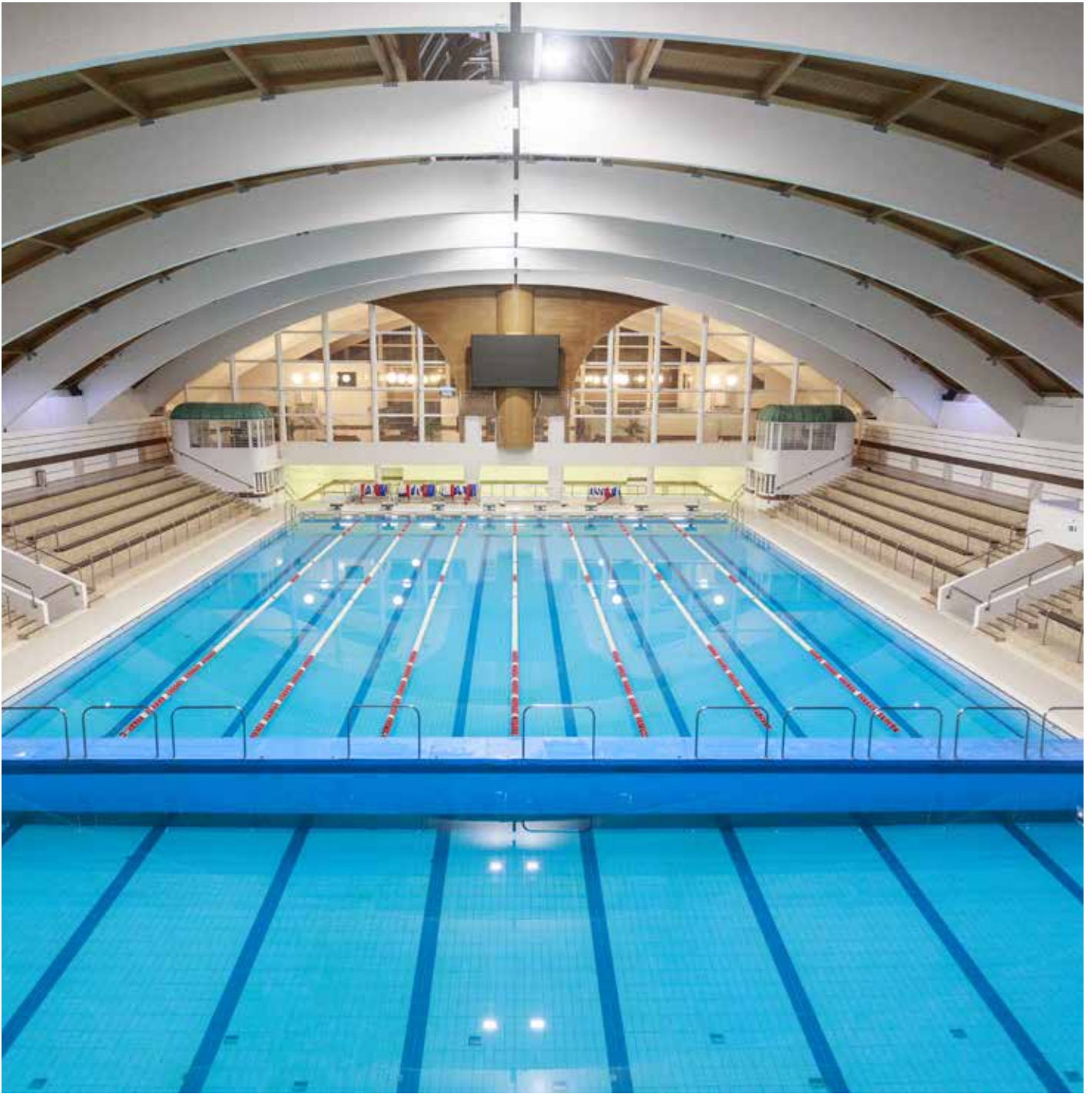

**NYEKI IMRE SWIMMING CENTER
BUDAPEST, HUNGARY**

Indoor Pool

Finnish System / Azul





**PISCINE MUNICIPALE LA TESTE-DE-BUCH
LA TESTE-DE-BUCH, FRANCE**

Architect
Atelier Arcos Architecture





**ARLOZOROV 97 SPORTS CENTER, TEL AVIV,
ISRAEL | MAYSLITS KASSIF ROYTMAN ARCHITECTS**

Indoor Pool

Finnish System / Tao Grey, Plomo & Blanco



Finnish System

A classic downward-sloping pre-deck system. The S9 blocks provide the necessary slope and grate support.

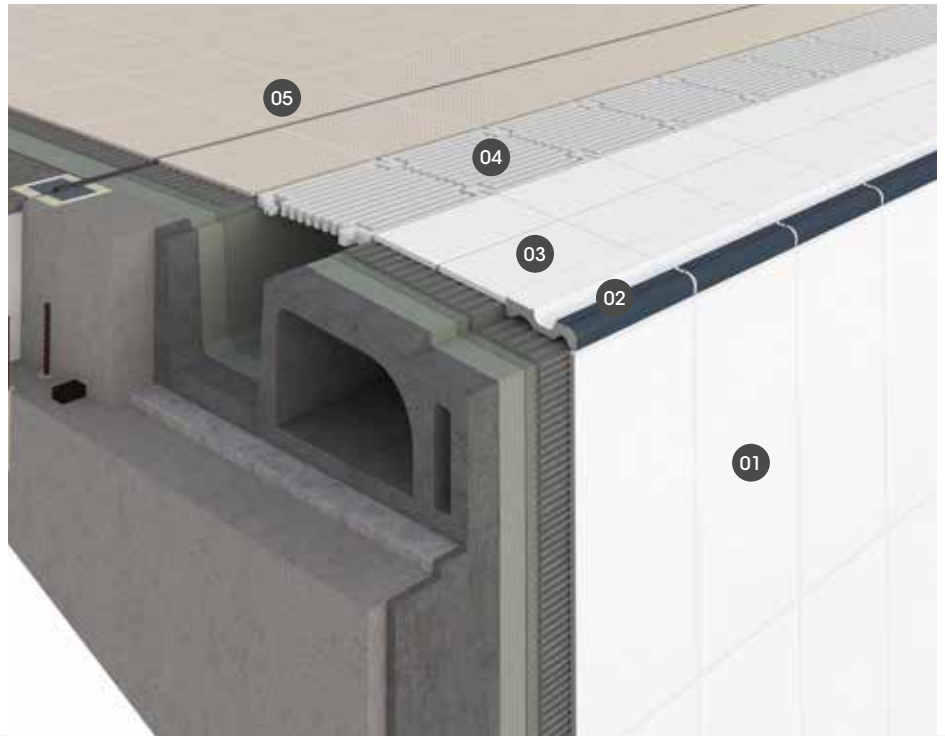
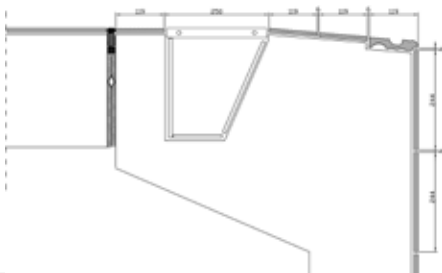

- 01** 244 smooth / anti-slip
Rosa Gres
24,4 x 49,4 cm
Porcelain tile
- 02** 007 anti-slip
Rosa Gres
24,4 x 11,9 cm
Porcelain tile
- 03** 001 anti-slip
Rosa Gres
11,9 x 24,4 cm
Porcelain tile
- 04** Plastic grid
- 05** 240 pastilla
Rosa Gres
24,4 x 24,4 cm
Porcelain tile

Edging tiles and corners

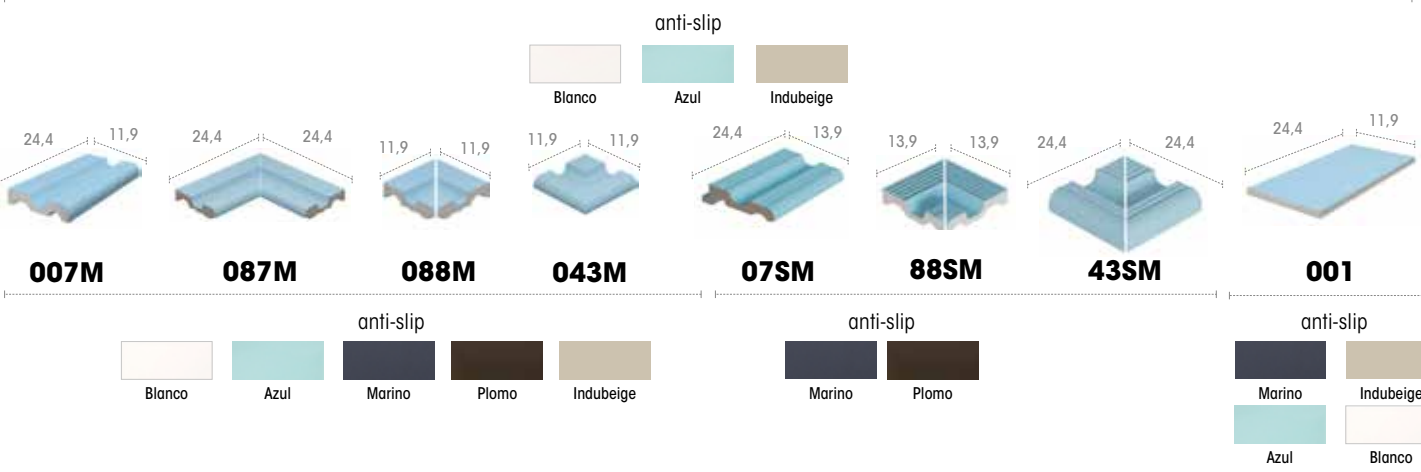
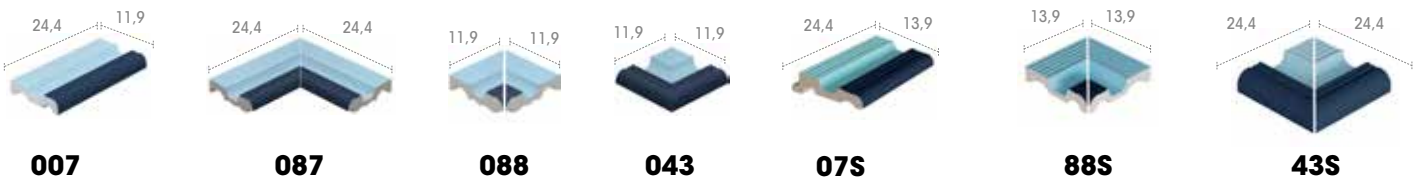
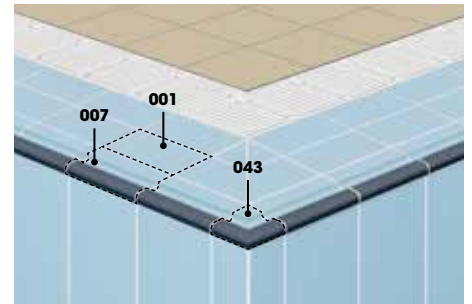
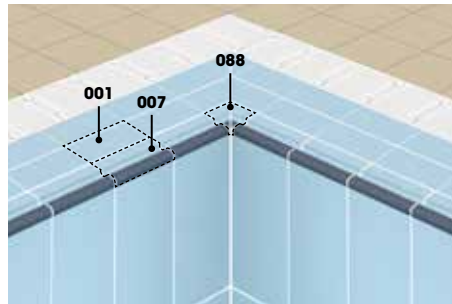
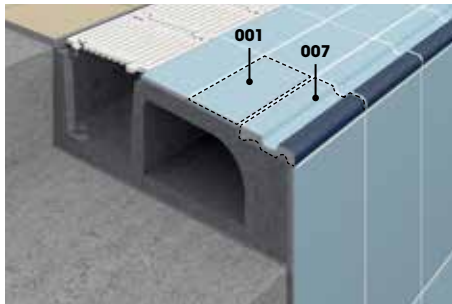

Wiesbaden System

This is ideal if you have a limited pool deck area and require a low price, guaranteed watertightness, a high-capacity channel, an easy installation and a wide range of colors.

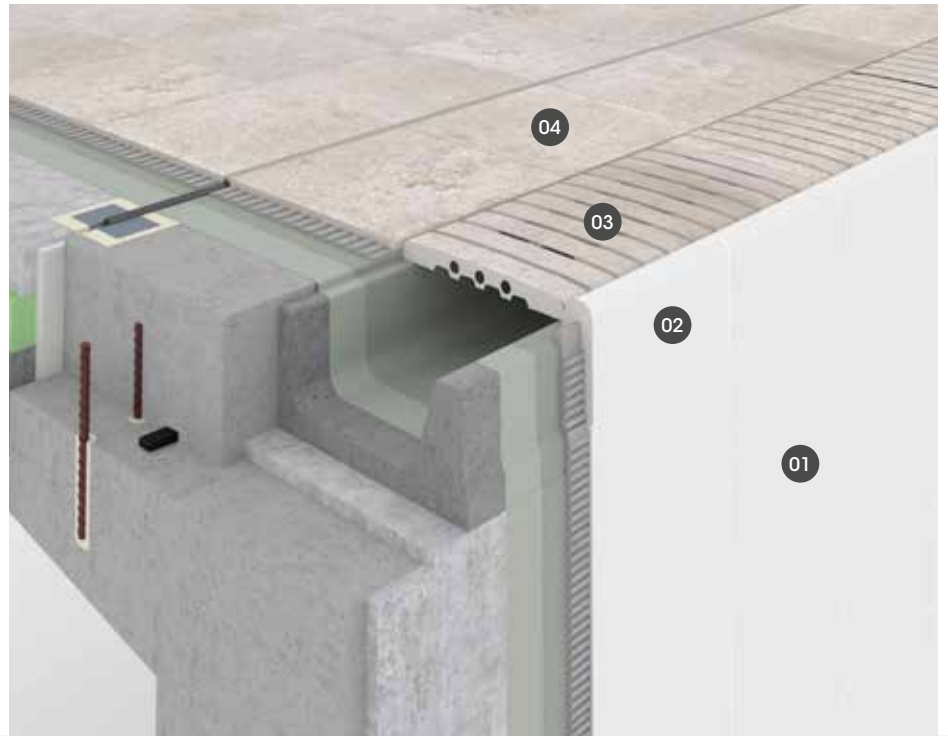
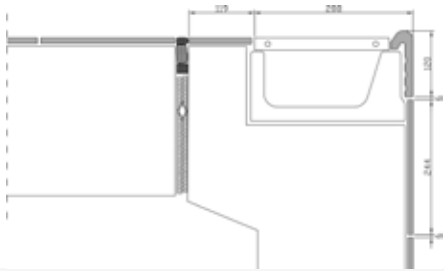

01 244 smooth / anti-slip
Rosa Gres
24,4 x 49,4 cm
Porcelain tile

02 971 smooth / anti-slip
Rosa Gres
24,4 x 12 cm
Porcelain tile

03 245 FL anti-slip
Mistery Grey Rosa Gres
24,5 x 49,5 x 2,2 cm
Porcelain tile

04 310 anti-slip
Rosa Gres
24,5 x 49,5 x 2,2 cm
Porcelain tile

Formats and Finishes

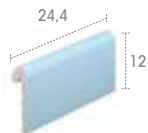
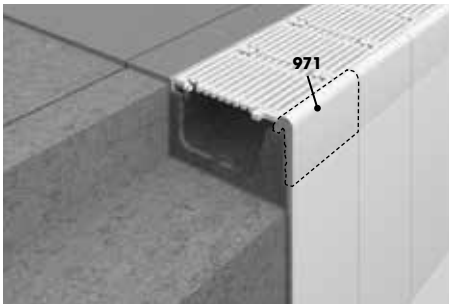

971

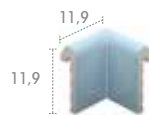
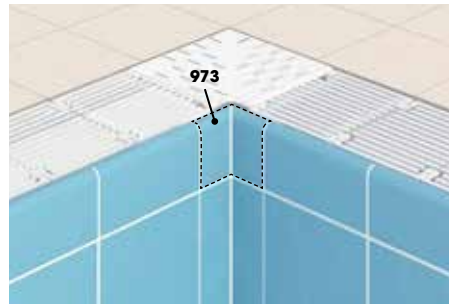

973

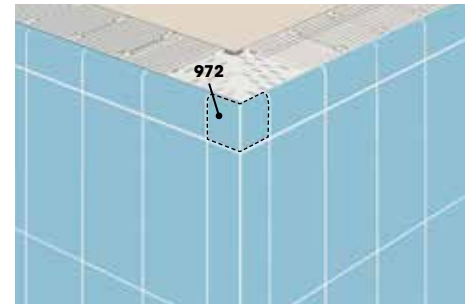

972

smooth / anti-slip



Horyzon System

Comprising 2 large format ceramic tiles that form a gentle slope and provide bathers a better grip.

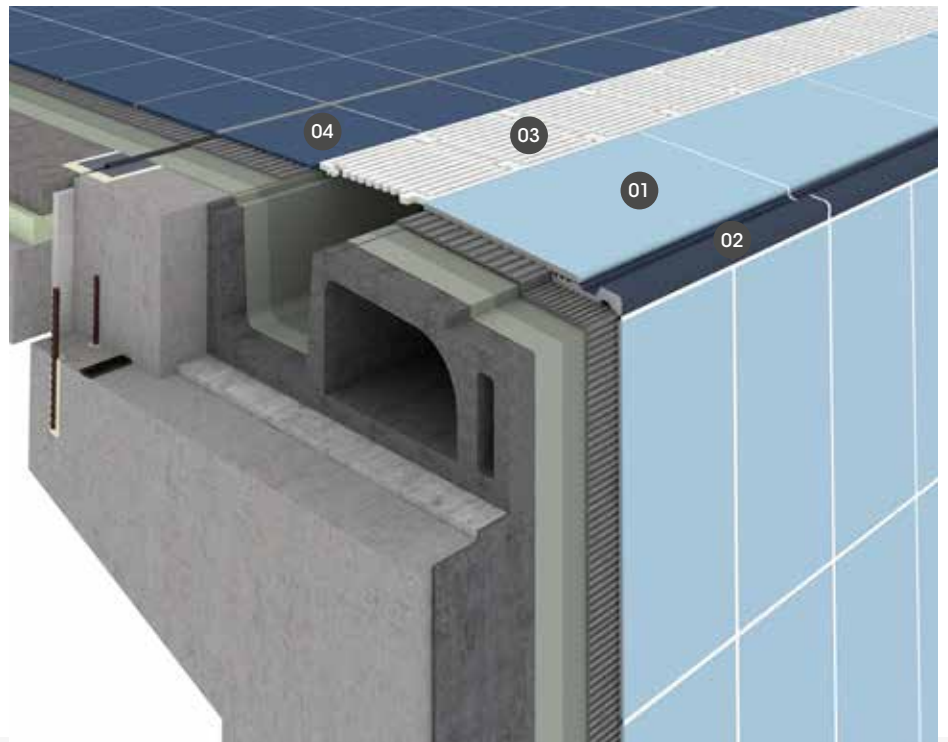
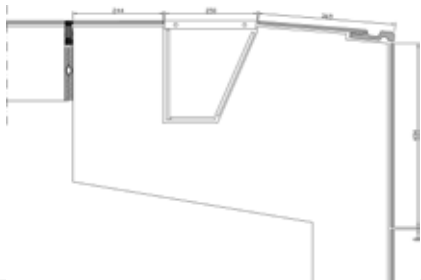

01

R49 anti-slip
Rosa Gres
29,7 x 49,4 cm
Porcelain tile

02

G49 anti-slip
Rosa Gres
11,9 x 49,4 cm
Porcelain tile

03

Plastic grid

04

240 pastilla
Rosa Gres
24,4 x 24,4 cm
Porcelain tile

Edging tiles and corners

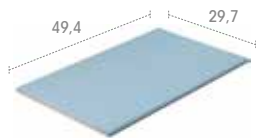
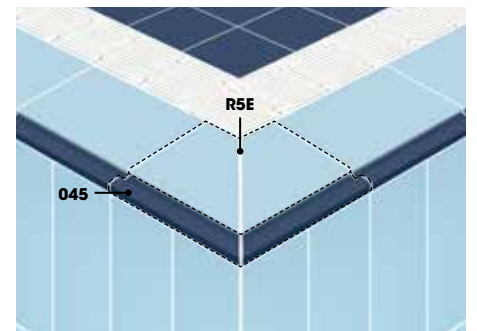
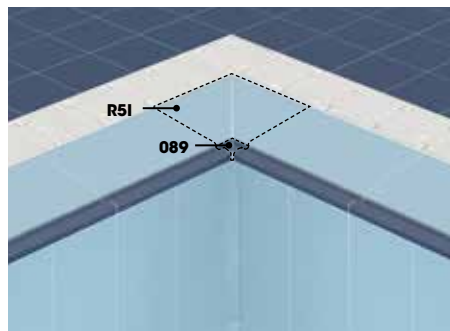
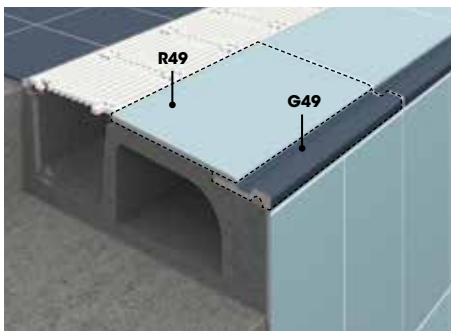

R49

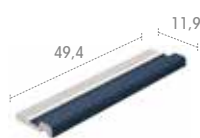

G49

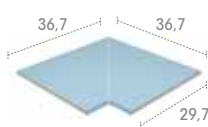

R51

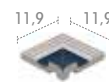

089

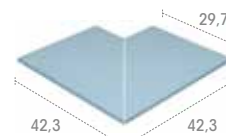

R5E

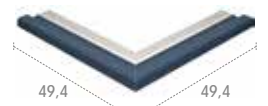

045

anti-slip



Ergo System

A downward-sloping pre-deck system with only two pieces. The edge piece provides the pre-deck slope and acts as a ceramic support for the grid.

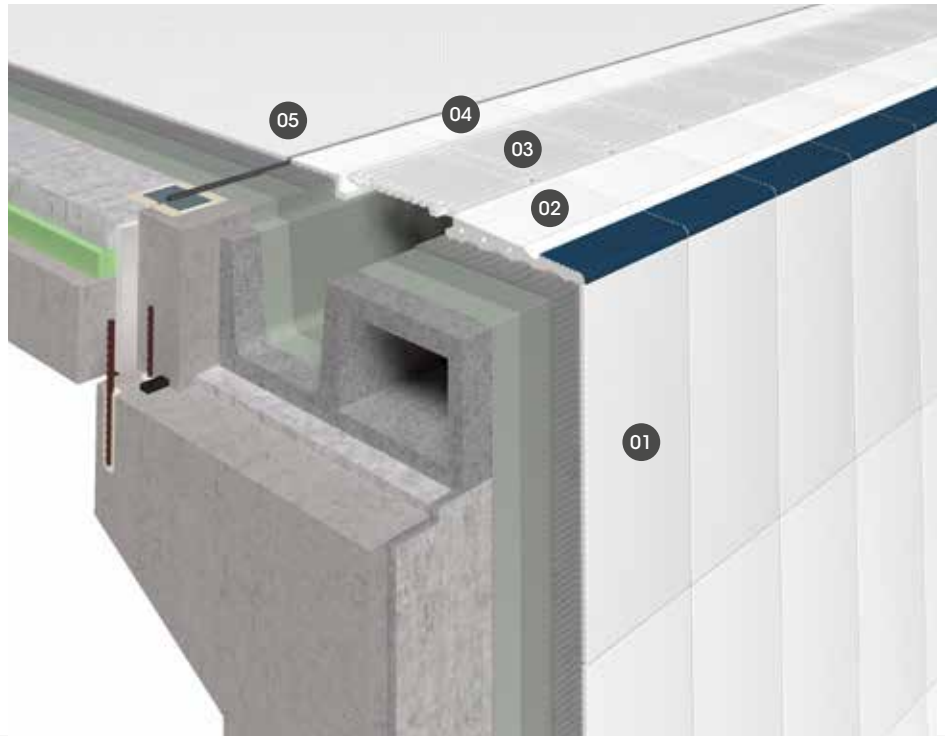
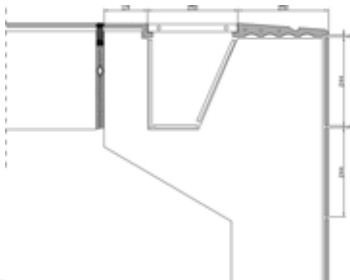

- 01** 244 smooth / anti-slip
Rosa Gres
24,4 x 49,4 cm
Porcelain tile
- 02** 216 anti-slip
Rosa Gres
24,4 x 26,2 cm
Porcelain tile
- 03** Plastic grid
- 04** 035 anti-slip
Rosa Gres
24,4 x 13,4 cm
Porcelain tile
- 05** 240 pastilla
Rosa Gres
24,4 x 24,4 cm
Porcelain tile

Edging tiles and corners

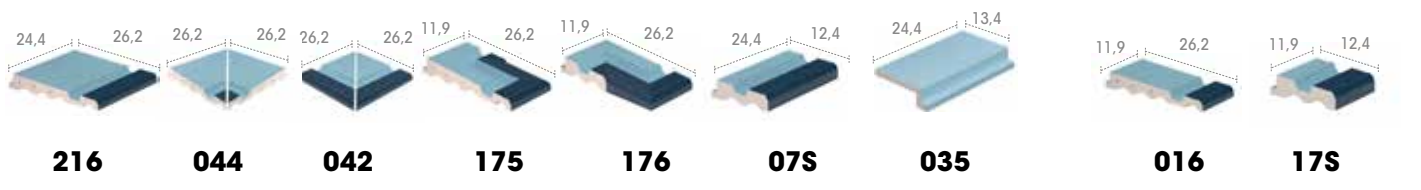
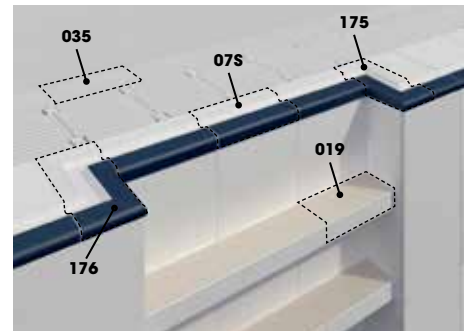
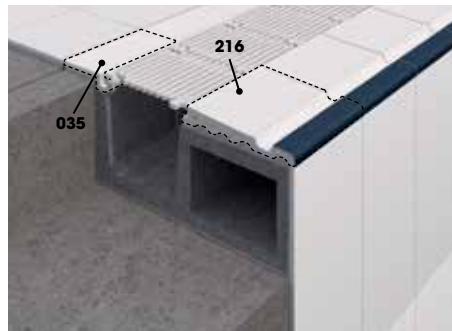
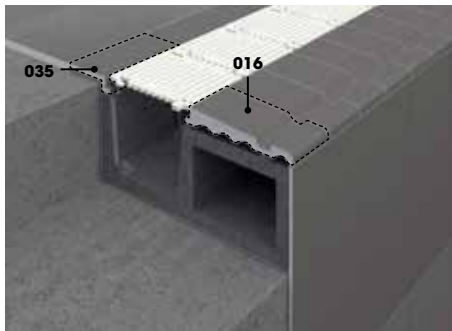

- | | | | |
|------------------|-----------|-----------------|-----------|
| anti-slip | | anti-slip | |
| | | | |
| Blanco | Azul | Blanco | Azul |
| | | | |
| Plomo Monocolor | Indubeige | Plomo Monocolor | Indubeige |
| | | | |
| Marino Monocolor | | | |

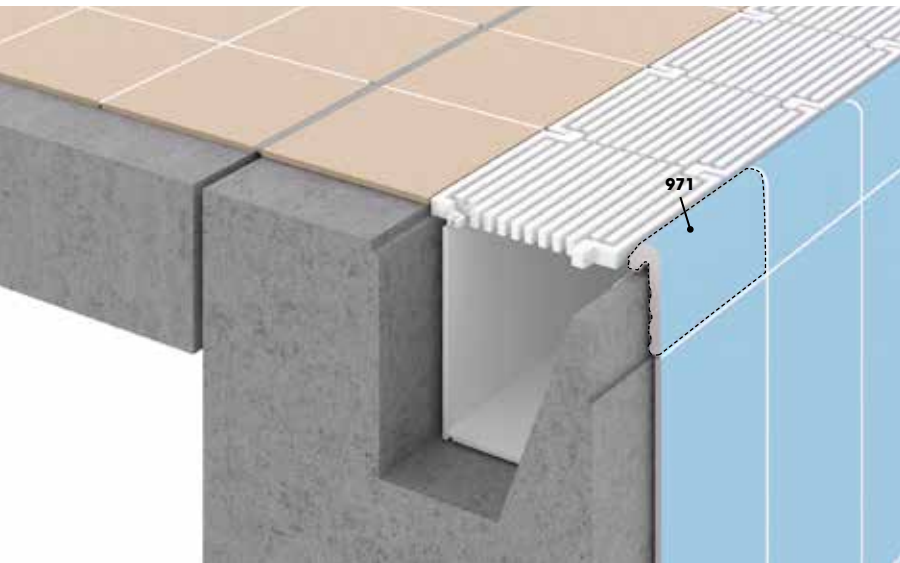

Australia A System

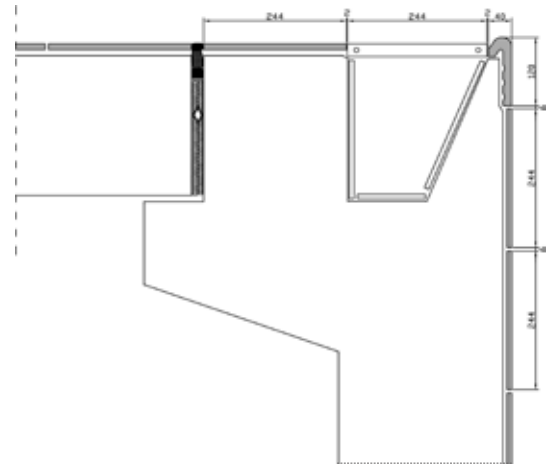

Edging tiles and corners

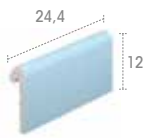

971
smooth / anti-slip



Australia B System

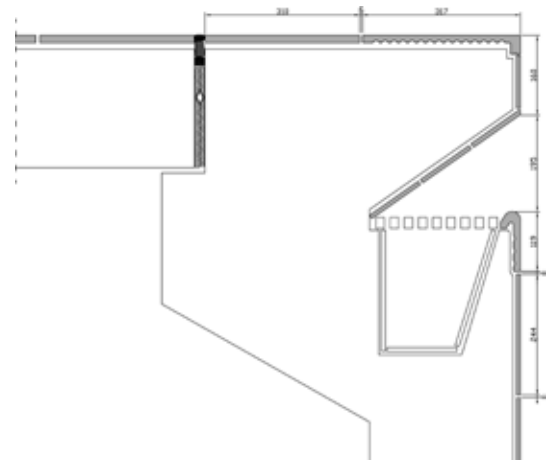

Edging tiles and corners

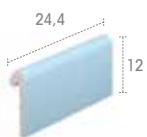

971
smooth / anti-slip



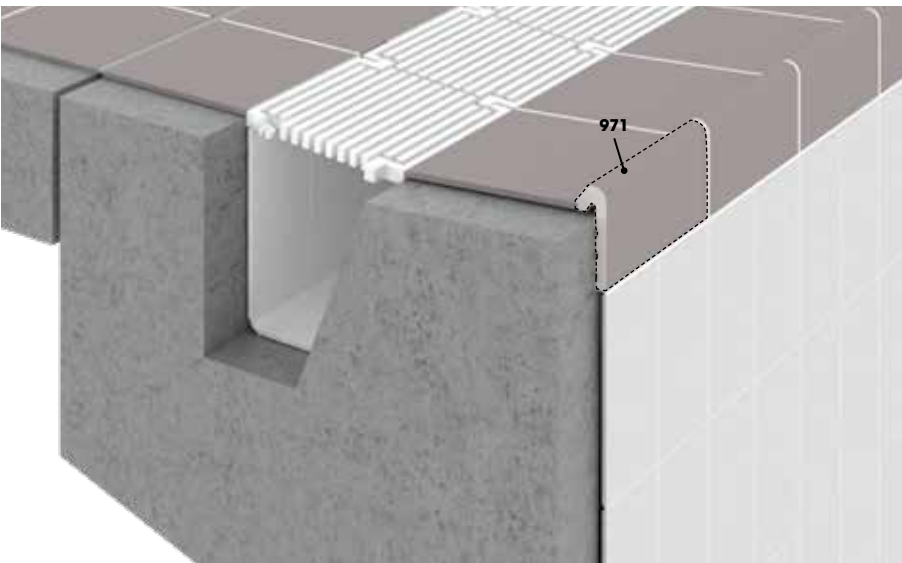

Munich System

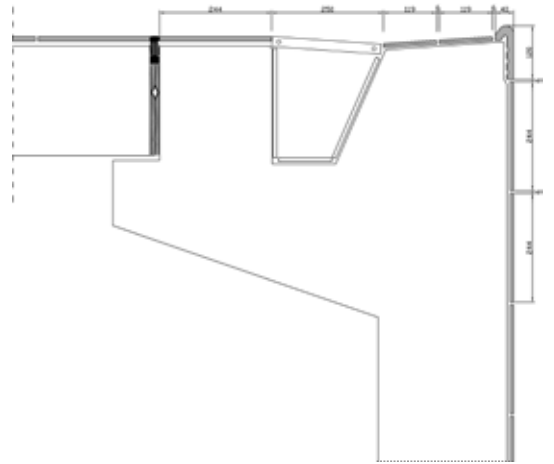

Edging tiles and corners

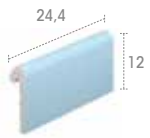

971
smooth / anti-slip

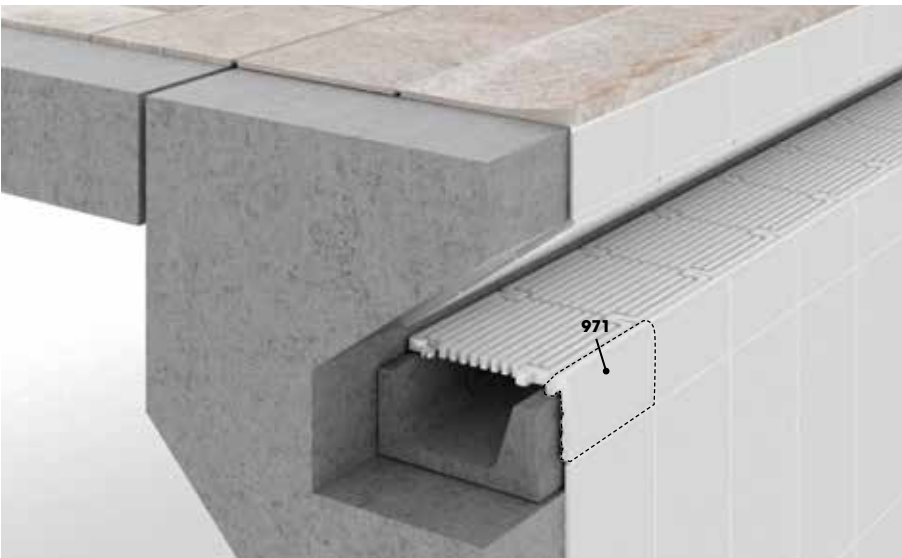

Wiesbaden B System

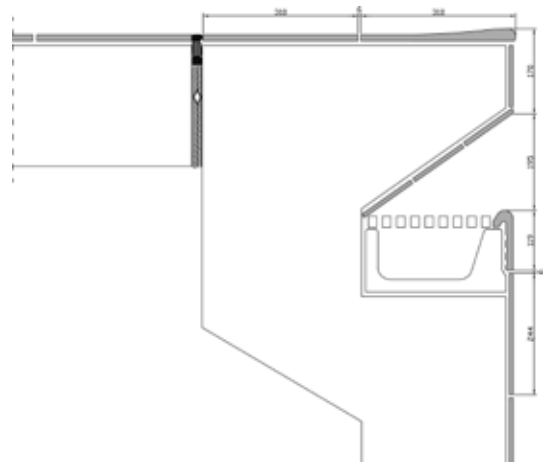

Edging tiles and corners

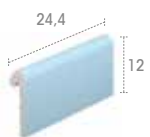

971
smooth / anti-slip



Aqua

Colors

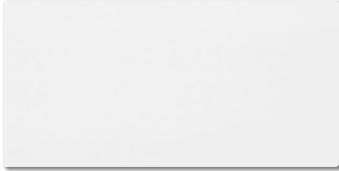

Blanco

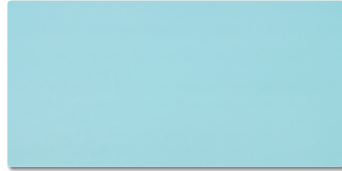

Azul

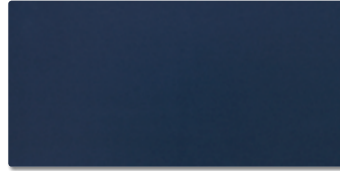

Marino



Prusia

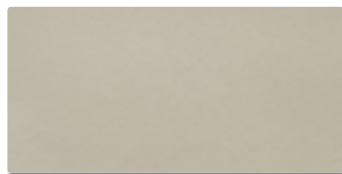

Habana



Oliva

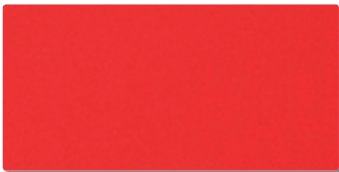

Rojo N



Amarillo



Plomo

Formats and Finishes

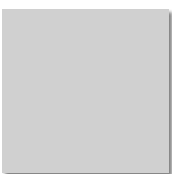

240 G1 pastilla
24,4 x 24,4 x 0,8
9 1/2" x 9 1/2"

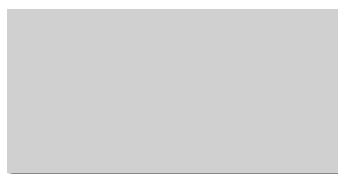

244 G1 smooth / anti-slip
24,4 x 49,4 x 0,8
9 1/2" x 19 1/2"



122 G1 smooth / anti-slip
11,9 x 24,4 x 0,8
4 1/2" x 9 1/2"



052 G1 smooth
5,6 x 24,4 x 0,8
2" x 9 1/2"

Mosaic

Colors

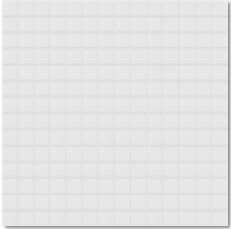

Blanco

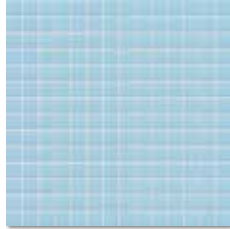

Azul



Marino

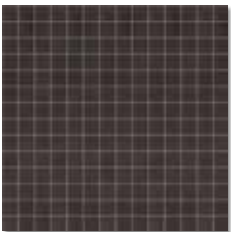

Plomo



Ivory

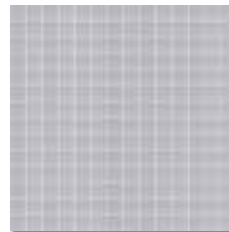

Perla

Aqua & Mosaic

Matching colors



Blanco



Azul



Marino



Plomo

Formats and Finishes

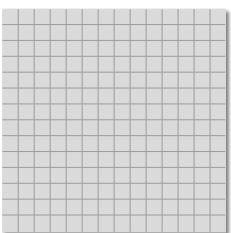

320 smooth / anti-slip
33 x 33 x 0,5
[2,3 x 2,3 / u]

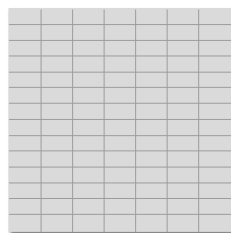

323 smooth / anti-slip
33 x 33 x 0,5
[2,3 x 4,6 / u]

Half-round pieces

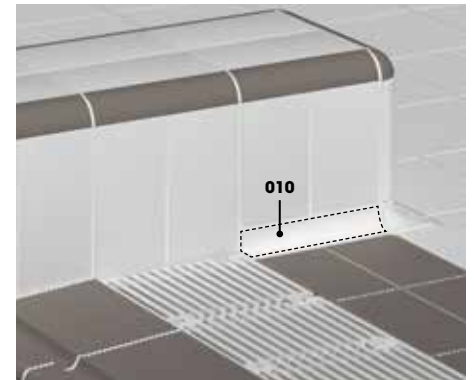
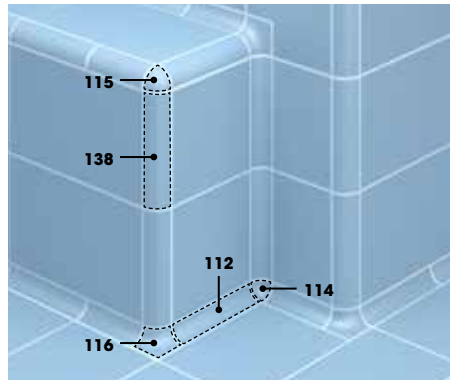
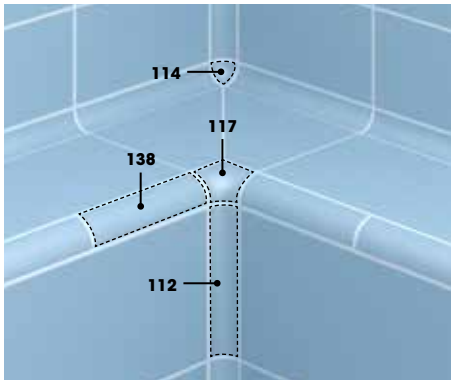

138

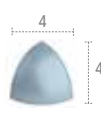

115

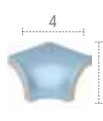

117



112

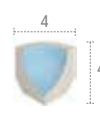

114

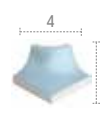

116

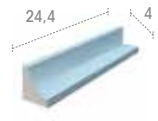

010

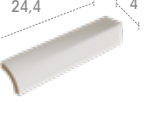

020

smooth			anti-slip			anti-slip			smooth			smooth	

Bullnose

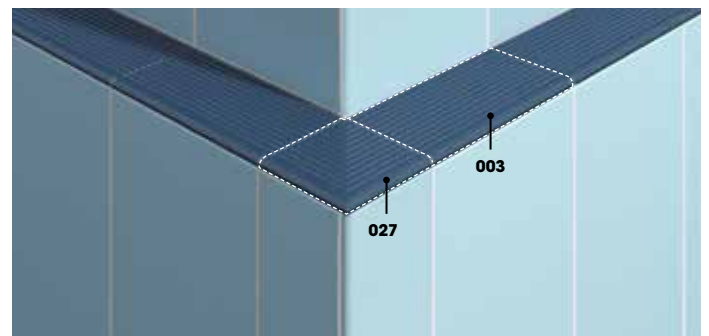
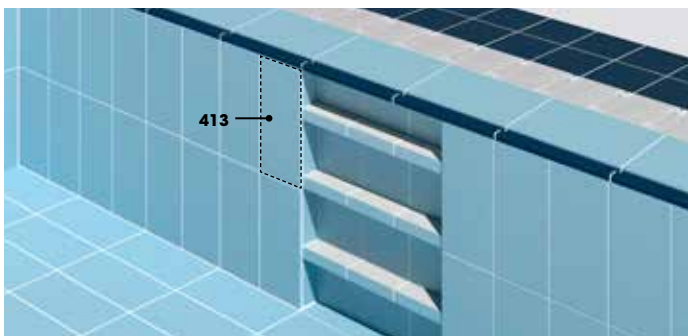

413

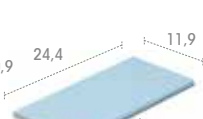

013



009



003



027

smooth		smooth / anti-slip		smooth / anti-slip		anti-slip		anti-slip

Bullnose

Grooved tiles

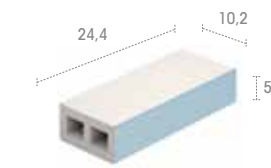
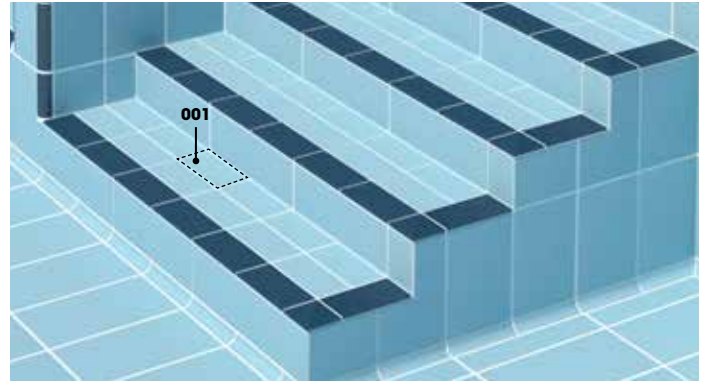
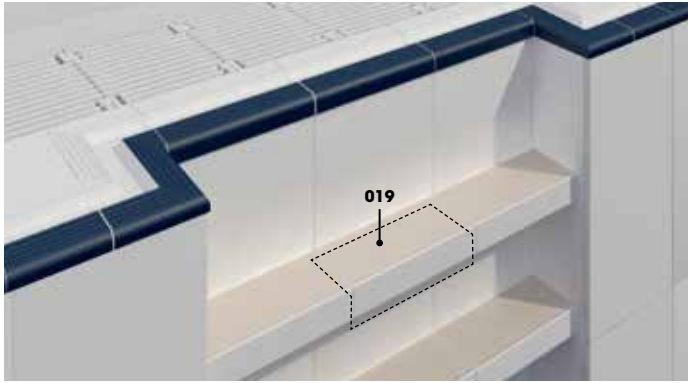

019

anti-slip

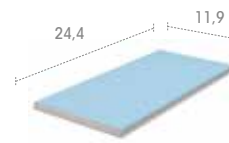
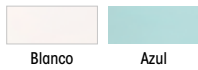

001

anti-slip



Depth tiles



122 N9



122 P9

smooth / anti-slip

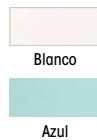

122 PO/122 P8

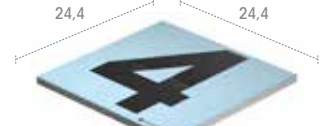

C01 / C08

smooth

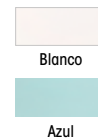

Colors



Plomo Pastilla



Indubeige Pastilla

Formats and Finishes

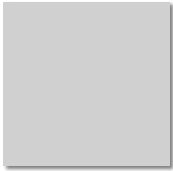

240 G1 pastilla

24,4 x 24,4 x 0,8
9 1/2" x 9 1/2"

Waterways

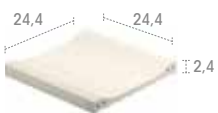
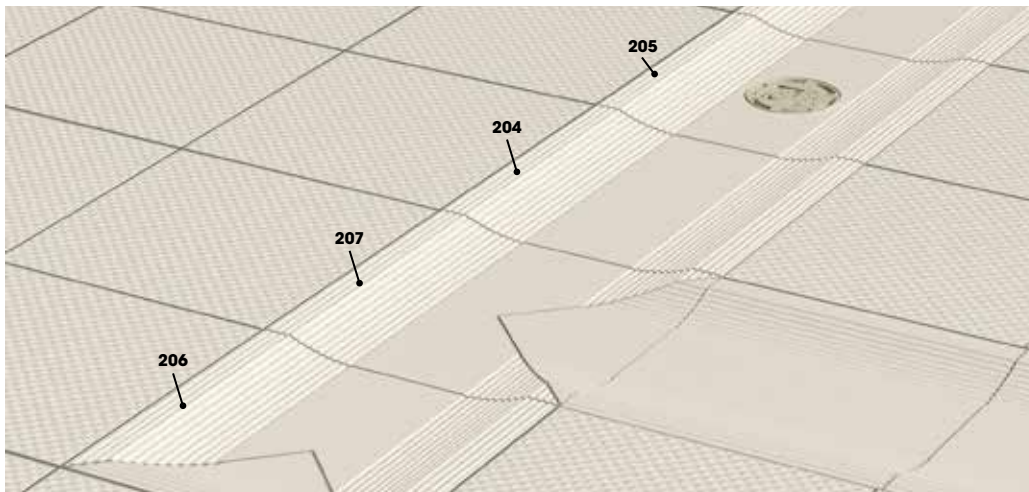

204

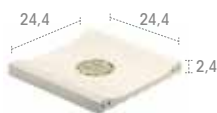

205



206



207

anti-slip





**14TH FINA WORLD CHAMPIONSHIPS - SHANGAI 2011
SHANGAI, CHINA**

Competition pools



trésor



Trésor Bali



Trésor Java

alma



Alma Mist



Alma Forest



Alma Honey



Alma Pure

stela *MIX*



Stela White



Stela Golden



Stela Grey



Stela Dark

pietro *MIX*



Pietro White



Pietro Golden



Pietro Grey



Pietro Dark

Formats **Trésor**



316 anti-slip
31 x 62,6 x 0,9



310 BH anti-slip
31,3 x 31,3

Mesh-mounted porcelain stoneware mosaic tiles

Formats **Alma**



199 smooth/anti-slip
19,41 x 97,9 x 1

Formats **Stela**



199 smooth/anti-slip
19,41 x 97,9 x 1

Formats **Pietro**



316 anti-slip
31 x 62,6 x 0,9



490 anti-slip
48,8 x 48,8 x 1



50M anti-slip
48,8 x 97,9 x 1



300 anti-slip
30,2 x 30,2 x 0,9

Rectified pieces, under request

serena



Serena Bianco



Serena Ocra



Serena Griggio



Serena Nero



Serena Mix *

* Available in 31 x 62,6 x 0,9

bohème



Bohème Vanille



Bohème Brune



Bohème Glacé



Bohème Nuit

mistry



Mistry White



Mistry Sand



Mistry Grey



Mistry Blue Stone

tao



Tao Beige



Tao Brown



Tao Silver



Tao Grey

Formats **Serena**



316 anti-slip
31 x 62,6 x 0,9



490 anti-slip
48,8 x 48,8 x 1



300 anti-slip
30,2 x 30,2 x 0,9
Rectified pieces, under request

Formats **Bohème**



316 smooth/anti-slip
31 x 62,6 x 0,9



490 smooth/anti-slip
48,8 x 48,8 x 1



300 anti-slip
30,2 x 30,2 x 0,9
Rectified pieces, under request

Formats **Mistry**



316 smooth/anti-slip
31 x 62,6 x 0,9



50M smooth/anti-slip
48,8 x 97,9 x 1



300 anti-slip
30,2 x 30,2 x 0,9
Rectified pieces, under request



310 BH anti-slip
31,3 x 31,3
Mesh-mounted porcelain stoneware mosaic tiles

Formats **Tao**



316 smooth/anti-slip
31 x 62,6 x 0,9



300 anti-slip
30,2 x 30,2 x 0,9
Rectified pieces, under request

Indugres

100% **Biostop** Finish

CERAMIC TILE THAT ELIMINATES BACTERIA

THE ONLY TOTAL SELF-PROTECTION SOLUTION:
PORCELAIN CERAMIC TILE AND SEALING GROUT

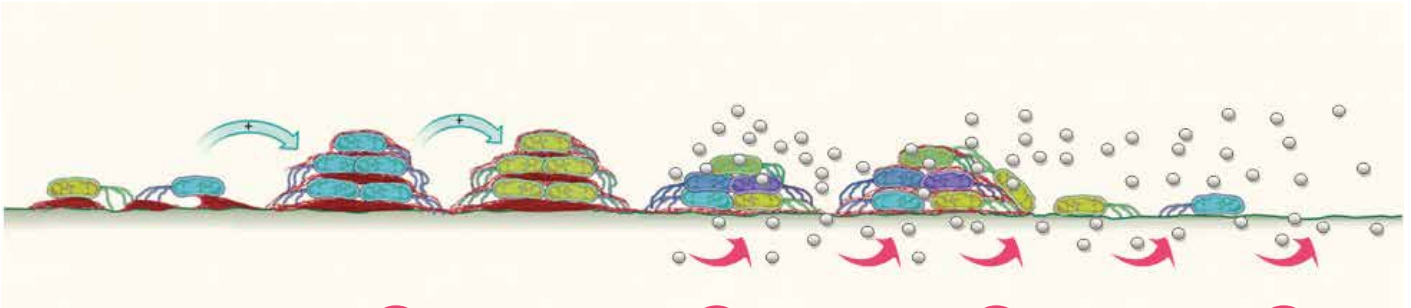

1

2

3

4

HOW DOES **Biostop** ACT

BACTERIA ADHERE TO THE SURFACE. IT TAKES ONLY ONE BACTERIUM TO CREATE CONTAMINATION AND PROLIFERATE.

NOXIOUS MICROORGANISMS CAN APPEAR ON ALL SORTS OF MATERIALS AND SURFACES.

THE COMBINATION OF BACTIBLOCK AND HUMIDITY LIBERATES THE IONIC SILVER. THE SILVER IONS INHIBIT THE MICROBIAL METABOLISM.

WITHOUT A CHANCE TO NEITHER SURVIVE NOR DEVELOP THE BACTERIA DISAPPEAR.



WORKS 24 H:
INDOORS AND
OUTDOORS



HIGH QUALITY
PORCELAIN STONEWARE



PERMANENT
SELF-PROTECTION



MINIMIZES
SMELLS



IT ISN'T TOXIC
TO HUMAN HEALTH

Formats and Finishes

244 G1
24,4 x 49,4 x 0,8



Bio White Smooth
24,4 x 49,4 x 0,8

122 G3
11,9 x 24,4 x 1



Indubeige R9
11,9 x 24,4 x 1

Indubeige R10
11,9 x 24,4 x 1

Indubeige R11
11,9 x 24,4 x 1

Indubeige R12
11,9 x 24,4 x 1

240 G3
24,4 x 24,4 x 1



Indubeige R10
24,4 x 24,4 x 1

Indubeige R11
24,4 x 24,4 x 1

Indubeige R12
24,4 x 24,4 x 1



Indu Grey R10
24,4 x 24,4 x 1

Indu Grey R12
24,4 x 24,4 x 1

Sealing grout



BIO-JUNTATEC WHITE / 10 KG/U
BIO-JUNTATEC GREY / 10 KG/U

Coloured cement mortar with protective properties: prevents growth of harmful microorganisms. Meets the ASTM E 2149 Standard.



BIO-CERPOXI WHITE / 22,5 KG/U
BIO-CERPOXI GREY / 21 KG/U

Coloured epoxy resin resistant to acid and with protective properties: prevents the growth of harmful microorganisms. Meets the ASTM E 2149 and ISO 22196 Standards.

Half-round pieces

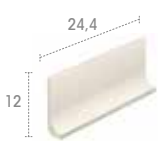
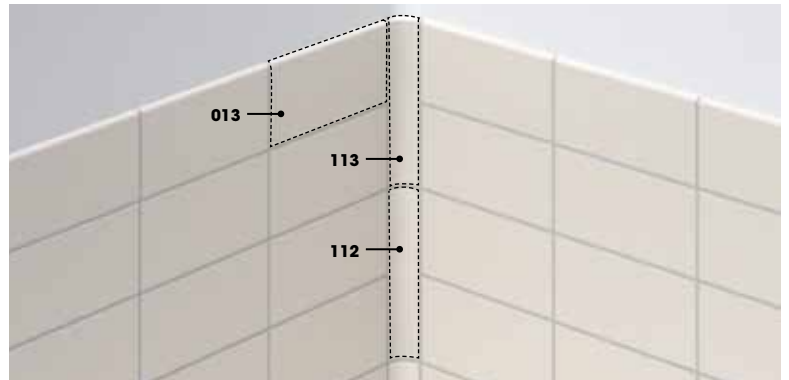
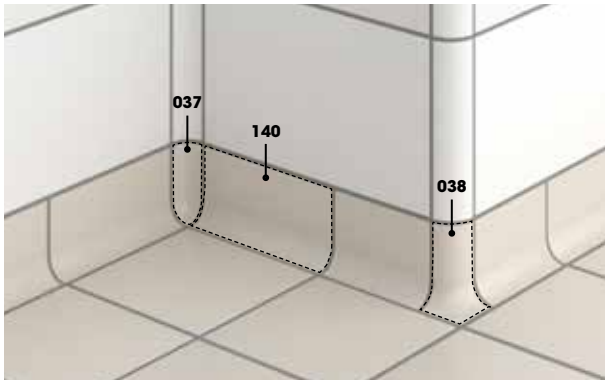

140



037

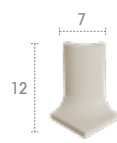

038

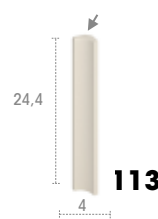

113

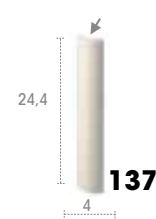

137



013



Indu Beige R9



Indu Grey R10

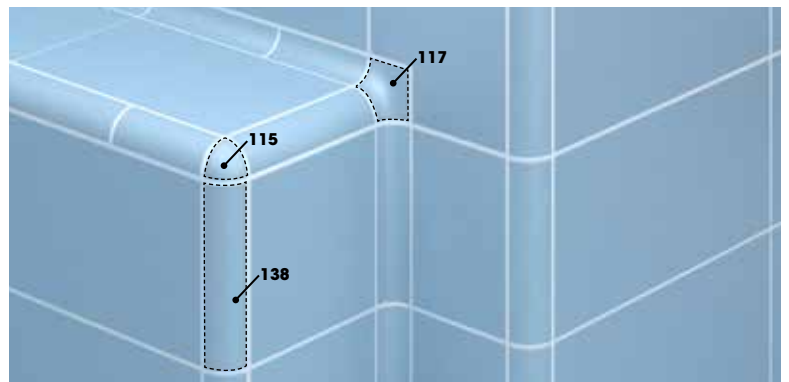
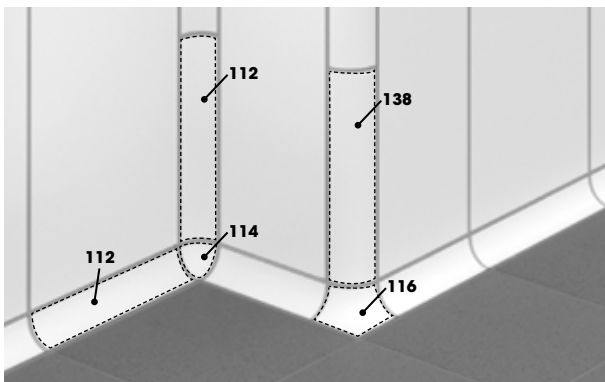

112



114



116



138



115



117



Bio - White



Indu Beige R9







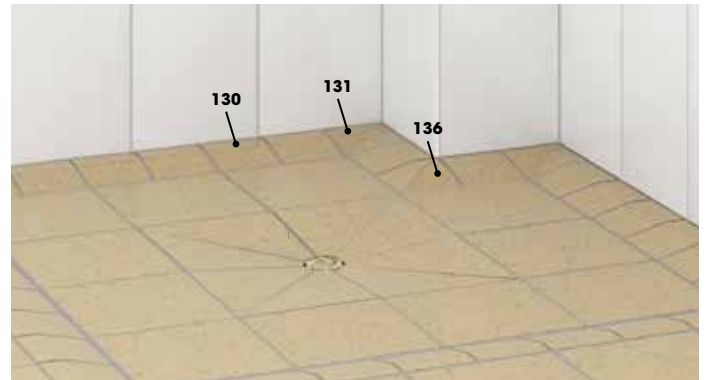
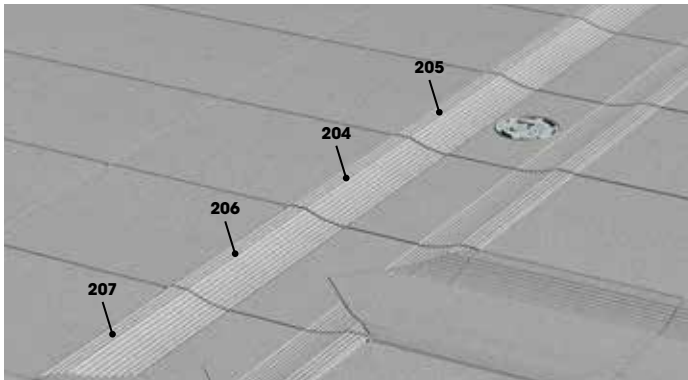



Indu Grey R10

Grooved tiles

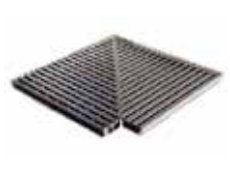

Grating

	GRATING		90° CORNER PLASTIC PIECE		LONGITUDINAL GRATE
245 R2 24,5 x 19,5 x 2,2 295 R2 29,5 x 19,5 x 2,2 335 R2 33,5 x 19,5 x 2,2		195 E2 19,5 x 19,5 x 2,2 245 E2 24,5 x 24,5 x 2,2 295 E2 29,5 x 29,5 x 2,2 335 E2 33,5 x 33,5 x 2,2	195 E3 20 x 20 x 3,5 245 E3 25 x 25 x 3,5 295 E3 30 x 30 x 3,5 335 E3 34 x 34 x 3,5	195 L2 19,5 x 20,6 x 2,4 245 L2 24,5 x 20,6 x 2,4 295 L2 29,5 x 20,6 x 2,4 345 L2 34,5 x 20,6 x 2,4	
	END PIECE FOR LONGITUDINAL GRATING		MODULAR GRATE FOR BENDS		GRATING SUPPORT PROFILE ⁽¹⁾
195 TO 19,5 x 2,4 245 TO 24,5 x 2,4 295 TO 29,5 x 2,4 345 TO 34,5 x 2,4		195 V2 19,5 x 2,2 245 V2 24,5 x 2,2 295 V2 29,5 x 2,2 335 V2 33,5 x 2,2	195 V3 19,5 x 3,5 245 V3 24,5 x 3,5 295 V3 29,5 x 3,5 335 V3 33,5 x 3,5	243 PF 2,4 x 3,7 x 200	
	GRATING ⁽²⁾		90° CORNER PLASTIC PIECE		LONGITUDINAL GRATE
245 R2 24,5 x 250 x 2,4		245 E2 24,5 x 24,5 x 2,4		245 L2 24,5 x 100 x 2,4	
	MODULAR GRATE FOR BENDS				
245 V2 2,5 x 250 x 2,4					

Cork floats line

	CORK FLOATS LINE ⁽³⁾		SLOPING ANCHORAGE		FLAT ANCHORAGE
ROMM2 25 ROMM5 50		ANIH1 Ø43 Tube ANIH2 Ø48 Tube		ANPH1 Ø43 Tube ANPH2 Ø48 Tube	
	CORK FLOATS HOLDER		ANCHOR CUP		SCREW ANCHOR
SPCH1 Ø43 Anchorage		CAE00 Retractable anchor		ANTH1 Ø43 Tube	

(1) 2 units required to hold the grid. Sold in units of 2 m





(2) Sold in units of 2'5 m

(3) Stairs with customized porcelain stoneware steps

(4) Anchorages not included

(5) Podium numbers not included

Stairs

	STAIR WITH HANDRAIL MODEL 1000		MODEL SPLIT STAIRS		STAIR WITH HANDRAIL ERGO MODEL
MILX3 3 Steps	MILX4 4 Steps	PTDX3 3 Steps	PTDX4 4 Steps	EPEZ3 3 Steps	EPEZ4 4 Steps
	ASYMMETRIC STAIR		EXTERNAL / INTERNAL HOLDER EXITS		
SMA00	2 Handrail 1000	PAS00	043 Steel Inox		

Signs

	FALSE START SIGNALING FOR POLES ⁽⁴⁾		SWIMMERS' START PODIUM ⁽⁵⁾		SIGNAL FLAGS ⁽⁴⁾
SS FH 1 Ø43 Poles SS FH 2 Ø48 Poles	SS FFC Polyester rope	PDAH7 70 cm high - blue		BDNH1 Ø43 Poles BDNH2 Ø48 Poles	BDNHBC 2 Strings and signal flags
	LIFE PRESERVER		HYDRAULIC ELEVATOR		LIFE PRESERVER SUPPORT
SAL PL Plastic	SAL LN Canvas	ELVML Handrail 1000	ELV65 Handrail 650	SSV00	PSV00 LIFE PRESERVER STAND SUPPORT

Other options





	POLYPROPYLENE ANCHORAGE		PVC DRAINS		DRAIN SILENCER		PP HOMOPOLYMER
ANEH1		990				EMB 00	

TESTING REGULATIONS	REGULATION EN 14411	Unique Pools	Sport Pools		
		Trésor / Stela Pietro / Serena Bohème / Alma Mistery / Tao	Aqua	Indugres	Mosaic

DIMENSIONS AND SURFACE QUALITY

ISO 10545-2	Dimensions and surface quality	Required	Guaranteed	Guaranteed	Guaranteed	Guaranteed
-------------	--------------------------------	----------	------------	------------	------------	------------

PHYSICAL PROPERTIES

 ISO 10545-3	Water absorption	Group A1a E < 0,5 %	Group B1a E < 0,5 %	E < 0,5 %	E < 0,5 %	E < 0,5 %	E < 0,5 %
 ISO 10545-4	Flexural strength	Group A1a > 28 N/mm ²	Group A1a > 35 N/mm ²	> 40 N/mm ²	> 40 N/mm ²	> 40 N/mm ²	-
 ISO 10545-6	Resistance to deep abrasion	< 175 mm ³	-	-	-	< 175 mm ³	-
 ISO 10545-9	Thermal shock resistance	Required	Guaranteed	Guaranteed	Guaranteed	Guaranteed	-
 ISO 10545-12	Frost resistance	Required	Guaranteed	Guaranteed	Guaranteed	Guaranteed	Guaranteed

CHEMICAL PROPERTIES

 ISO 10545-13	Chemical resistance ⁽¹⁾	Min. Class B	GLA	GLA	ULA	GLA
 ISO 10545-14	Stain resistance	Min. Class 3	Guaranteed	Guaranteed	Guaranteed	Guaranteed

(1) Except hydrofluoric acid and its components

Base pieces:

Group B1a pressed porcelain tiles

Trim pieces:

Group A1a extruded porcelain tiles

Minimum joint (Field tiles)

A 2 mm joint is needed. A minimum joint of 3 mm is recommended for the following formats: 48.8 x 48.8 cm and 48.8 x 79.2 cm. When it's necessary to modulate field tiles with trim pieces, the joint should be 6 mm.

* Biostop (tiles and grout) complies with the JIS Z 280: 2000 Antimicrobial efficiency regulation.

ANTI-SLIP COEFFICIENTS

			UNE ENV 12633			DIN 51130 XP P-05-010				DIN 51097 XP P-05-010		ANSI A137.1	
			Class 1	Class 2	Class 3	R9 / PC6	R10 / PC10	R11 / PC20	R12 / PC27	Class B / PN18	Class C / PN 24	> 0.42	
Unique pools	trésor	anti-slip		●	●		●			●	●	●	
	stela	smooth	●			●							
		anti-slip			●						●	●	
	pietro	anti-slip			●					●	●		
	serena	anti-slip			●					●	●		
	bohème	smooth	●			●						●	
		anti-slip			●						●	●	
	alma	smooth	●			●						●	
		anti-slip			●						●	●	
	mistery	smooth	●			●							
anti-slip				●						●	●		
tao	smooth	●			●								
	anti-slip			●						●	●		
Sport pools	aqua	pastilla anti-slip Tank			●						●		
	mosaic	anti-slip			●						●		
	Indugres	Indubeige pastilla				●						●	●
		Indubeige R9	●			●							
		IndubeigeR10		●			●			●		●	
		Indu Grey R10		●						●			
		Indubeige R11			●			●		●			
		Indubeige R12			●				●		●	●	
		Indu Grey R12			●				●		●		





Rosa Gres, SLU

Central office

Ctra. Sant Cugat, km. 3
08290 Cerdanyola, Barcelona, Spain
Tel. + 34 93 586 30 60
Ventas: + 34 93 586 37 00
Export Sales: + 34 93 586 37 02
info@rosagres.com
www.rosagres.com

Rosa Gres France, SARL

66, Chemin Mirassou
64140 Lons, France
Tel. + 33 04 11 92 00 30
contact@rosagres.com
administration@rosagres.com
www.rosagres.com/fr

Factory

Pol. Ind. Mas Vell
Ramón Sugrañes, 1
43144 Vallmoll, Tarragona, Spain

May 2021

